

**Canon**

**EOS** **DIGITAL**  
**REBEL**  
**XTi**

**WHITE PAPER**



**THE CANON EOS DIGITAL  
REBEL XTi CAMERA:**

**MORE REGAL THAN REBEL:  
THE FINEST PERFORMANCE  
AND THE BEST VALUE IN THE  
UNDER \$1000 CATEGORY**

<b>Table of Contents</b>	<b>I OVERVIEW</b>	<b>3</b>
	<b>II NEW AND IMPROVED FEATURES</b>	<b>5</b>
	<b>III FEATURE DISCUSSION</b>	<b>6</b>
	Newly Developed 10.1 MP Sensor	6
	Comprehensive Dust Reduction System	7
	New 9-point AF System	10
	New 2.5-in. TFT LCD Screen	13
	Display-off Sensor	13
	New User Interface	14
	<i>Basic Operation Concept</i>	14
	<i>New Info Display Items</i>	15
	<i>Viewfinder</i>	15
	<i>SET Button, Cross-Keys, DISP.</i>	15
	<i>Improvements to Playback</i>	16
	<i>Menus</i>	16
	<i>Picture Style</i>	17
	<i>Custom Functions</i>	17
	Camera Direct Printing	17
	Direct Image Transfer	18
	Design and Construction	19
	Interface	20
	Drive and Power Source	20
	Folders	21
	Accessories and System Compatibility	22
	Software	23
	<b>IV SPECIFICATIONS</b>	<b>24</b>
	<b>V CONCLUSION</b>	<b>28</b>

# I. OVERVIEW

The Canon EOS Digital Rebel XTi is the best entry-level digital single lens reflex (DSLR) camera on the market today. Compared with its competitors at the sub-\$1000 price point, lens included, the XTi produces the finest images with the purest colors and the lowest noise, and has the most comprehensive solution to the problem of dust on the sensor. It also has the clearest and most elegant user interface, the fastest and most precise autofocus, and the most powerful and useful software package.

The original Canon EOS Digital Rebel, introduced in September, 2003, was the first interchangeable lens DSLR marketed for less than \$1000 including a lens, the EF-S 18-55 mm zoom. Purchasers were delighted to find the camera small, light and easy to handle. Its image quality was remarkable thanks to its high-quality Canon CMOS sensor, producing lower noise levels than more expensive rival products offered. The original Digital Rebel enjoyed immense success in the marketplace, selling more than 1.2 million units worldwide in less than 18 months. In March, 2005, Canon introduced the second generation Digital Rebel XT with an 8.0 megapixel CMOS sensor vs. the 6.3 MP CMOS sensor of the Digital Rebel. The new camera was 3 ounces lighter and a half inch smaller than the original. A newly-developed DIGIC II image processor made the XT much faster, yet more frugal with battery power. E-TTL II flash control, nine Custom Functions, White Balance Bracketing, long-exposure noise reduction, a monochrome mode and a host of other changes gave XT users tremendous control over the photographic process. It was amazing that Canon could sell this camera for less than \$1000, lens included. Once again, Canon had a wildly successful DSLR.



The new Canon EOS Digital Rebel XTi builds on this inheritance. It uses a new, highly evolved 10.1 megapixel CMOS sensor that is designed and manufactured entirely by Canon using equipment which was also designed and manufactured by Canon. In this and many other respects, Canon is unique in the world of photography. Canon's world-leading R&D division (second or third globally each year for 14 consecutive years in the number of U.S. patents granted) sees to it that every Canon DSLR has the highest image quality and the lowest noise in its category.

- Canon designs, develops and manufactures its own EF lenses, its own CMOS image sensors, and its own DIGIC image processors, with proprietary technologies that it doesn't sell to anyone else.
- Canon's original EOS Integrated Cleaning System gives the Digital Rebel XTi a comprehensive dust cleaning and management system offered by no other camera at any price.
- The Digital Rebel XTi has a 9-point, high-precision autofocus unit that it shares with the EOS 30D. The central sensor of the AF unit enhances precision with f/2.8 or faster lenses, a professional feature exclusive to the XTi in its category.
- The XTi has a new, large, bright, sharp, easy to read 2.5-inch color display and a new user interface that make the camera a delight to use. Picture Style, an improved Direct Print function, Print/Share, and a host of other improvements make the Digital Rebel XTi the highest performing member yet of the Digital Rebel family. The XTi builds on the successes of its predecessors, each of which was a superstar in its own right. With the Digital Rebel XTi, Canon goes from strength to strength, adding and refining features to make the XTi the finest camera today in the under-\$1000 category.

## II. NEW AND IMPROVED FEATURES

- New class-leading 10.1 megapixel Canon CMOS image sensor with improved microlens array
- Comprehensive EOS Integrated Cleaning System including Self Cleaning Sensor Unit and Dust Delete Data detection
- Large and bright 2.5 inch, 230,000 pixel LCD screen with wide viewing angle
- New, easy-to-use interface for camera settings with enhanced display information
- Expanded Info screen including RGB histogram and CF card remaining capacity
- Continuous shooting at 3 frames per second, best-in-class burst rate of 27 consecutive frames JPEG (Large/Fine) or 10 RAW frames
- Flexible folder management with manual folder creation and up to 9,999 images per folder
- Picture Style settings
- High-precision 9-point autofocus unit with f/2.8 support
- Selectable AF modes
- Selectable AF points
- 3 settings for long exposure noise reduction, including auto
- Faster image processing
- Improved Print/Share functions
- Improved Direct Print functions including red-eye correction, face brightening and index printing
- Convenient image display functions including computer-only auto rotation and reduce/enlarge during quick review
- Additional Custom Functions
- Superior software package including Canon's exclusive Digital Photo Professional



# III. FEATURE DISCUSSION

## Newly Developed, High-Resolution 10.1 Megapixel CMOS Sensor



10.1 Megapixel CMOS Sensor

The all-new Canon CMOS sensor in the EOS Digital Rebel XTi gives this camera the highest overall performance in its class. Like all other Canon CMOS sensors, this unit is designed and manufactured by Canon using semiconductor manufacturing equipment which was also designed and manufactured by Canon. This fully-integrated design and manufacturing system makes Canon unique in the photo industry. Canon has now produced over 5 million CMOS sensors, all for use exclusively in Canon DSLR cameras. The experience this achievement represents, in addition to constant R&D efforts, has enabled Canon to refine and improve its image sensors to their current remarkable level.

The image sensor in the Digital Rebel XTi measures 22.2 by 14.8 mm. Each of its 10.1 million pixels measures 5.7  $\mu\text{m}$  square. Its predecessor, the Digital Rebel XT, had 8.0 megapixels, each measuring 6.4  $\mu\text{m}$  square. Several improved technologies help the XTi to continue the Canon tradition of offering a wide range of ISO settings (100-1600), all of which are highly usable and characterized by very low noise despite the smaller pixel size that is a function of higher resolution. First, the spacing between the on-chip microlenses is now about half of the Digital Rebel XT's. This new configuration gathers light much more effectively, loses less light between the microlenses, and improves light convergence. Second, a higher percentage of each pixel's surface area is sensitive to light. Third, the output amplifiers have been optimized, lowering noise. Last, the second-generation, on-chip noise reduction circuit minimizes random noise and removes fixed-pattern noise. As a result, the XT and the XTi have the same signal-to-noise ratio and equivalent dynamic ranges despite the smaller pixels of the XTi. Finally, the 3 frames-per-second continuous shooting speed of the XT has been maintained notwithstanding the larger file size of the XTi. The combination of two-channel read-out from the sensor, increased processor clock speed and improved performance of the output amps is responsible for this accomplishment.

The infrared-blocking, optical low-pass filter is an integral part of the sensor package, and is divided into two individual components for the first time. Low-pass filter #1 is part of the Self Cleaning Sensor Unit. Its front surface is coated with a dichroic mirror that reflects infrared wavelengths. LPF #1 also separates the subject image into two

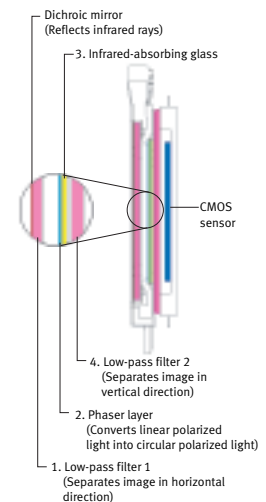

images horizontally. The phase plate, or phaser layer, converts the images separated by LPF #1 from linear polarization to circular polarization and prepares these polarized components to be correctly separated into four square images by low-pass filter #2. The hybrid infrared-absorption glass reflects and absorbs infrared light, effectively suppressing red ghosting and color casts caused by reflections on the sensor surface. The subject image divided into two images horizontally by the low-pass filter is separated vertically into two images by low-pass filter #2. The image is thereby properly separated into four square images. The image separation width for the vertical and horizontal images is optimized for the sensor pitch, minimizing color artifacts and moire caused by minute horizontal- and vertical-line patterns. As in the case of the Canon EOS 5D, low-pass filter #2 also serves as the CMOS sensor package's cover glass, eliminating a relatively expensive glass cover and reducing cost.

### Extraordinary New Dust Reduction System

Most modern camera stores now have a department devoted to dust removal tools: brushes sized to match sensors, electronic brushes, brushes that spin, solutions- in liquid and tablet form- for cleaning brushes, swabs of many types, wipes, grabbers, sticks, sleeves, liquids (ethanol, methanol and mysterious agents), rubber bulbs both large and small, chamber cleaning swabs and solutions, and, of course, more. The reason for this profusion is that digital SLRs with interchangeable lenses are susceptible to dust particles entering the camera when the lens is changed. The dust can settle on the sensor and leave a spotty mess on photographs, especially in less variegated areas like skies and clouds. The dust needs to be removed periodically, but touching a sensor is regarded (properly) by most people, no matter how skilled or prepared, as something to be avoided until or unless it is absolutely unavoidable.

In the Digital Rebel XTi, Canon offers an astute new approach to the dust problem: a self-cleaning sensor unit and Dust Delete Data software. Traditional manual sensor cleaning remains an option, of necessity, but it now needs to be done much, much less often, if at all, depending on shooting conditions and photographers' habits. The overall strategy is one of, first, neither generating nor attracting dust. The shutter unit (the same as in the Digital Rebel XT) generates minimal dust; the body cap (incorporated since the first half of 2005) is now made of a material which minimizes dust caused by normal wear and rubbing, and the low-pass filter is treated with an anti-static charge process to prevent static-charged dust from adhering to it.

In the course of developing this unit, Canon engineers analyzed the causes, types and sizes of visible dust. The dust becomes most noticeable at small apertures, so they studied what sizes of dust were the worst offenders at small apertures. The Self Cleaning Sensor Unit was then designed to eliminate those types of dust most effectively. Low-pass filter #1 on the front of the sensor is attached to an ultrasonic vibrating unit driven by a piezoelectric element. When LPF #1 is subjected to ultrasonic vibrations, the adhering dust is shaken off the surface.

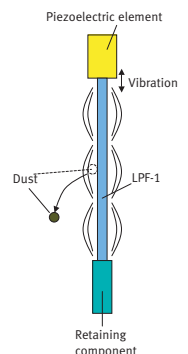

The removed dust then sticks to an absorbent material ringing the low-pass filter. The sensor unit also has an internal O-ring around the perimeter to keep out dust. The area between LPF #1 and the CMOS sensor is thus sealed; dust cannot enter from the side.

Instead of a dust-removal system which uses a vibrating glass, the Digital Rebel XTi uses its low-pass filter to vibrate directly, shaking off dust. Therefore, the optical performance is not degraded by an extra sheet of glass, and compactness is maintained. The camera body size is virtually the same as that of the Digital Rebel XT.

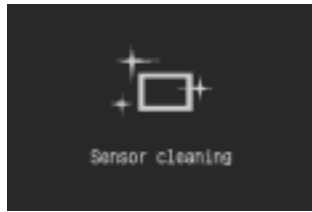
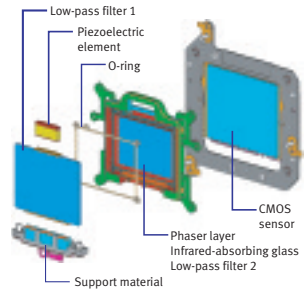

The default setting for the self-cleaning sensor has the cleaning unit operating for 1 sec. when the camera's power switch is turned on or off. Dust is therefore removed before shooting and after shooting is completed, the latter instance because dust is more difficult to dislodge after it has been stuck for a long time. Self-cleaning

can be enabled or disabled by setting "Clean when the power switch is turned <ON> or <OFF>" to [Enable] or [Disable]. During self-cleaning operation, the LCD screen displays an appropriate self-cleaning system logo.

The self-cleaning system can also be activated manually with the menu item [Clean now]. Note that shooting priority still holds. If you press the shutter button halfway or press the menu button during the self-cleaning operation (in either the Auto or Manual modes), the cleaning operation will stop and the camera will be ready to shoot. Pressing the shutter button during the internal processing startup sequence (immediately after the 0.2 second startup) will make shooting possible at that moment and sensor cleaning will not occur.

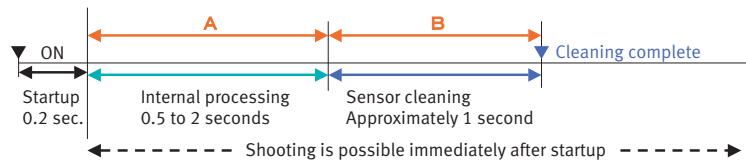

During manual cleaning with the reflex mirror locked up, the LCD screen will indicate that sensor cleaning is in progress. When the battery level is low, the following warnings are given: First, the beeper will sound even if [Beep] is set to [Off]. Second, a warning message is displayed on the LCD screen until the prohibited voltage is reached.

Because the self-cleaning system requires exceptionally low power, the number of possible shots from a charged battery is not reduced measurably.

To prevent the piezoelectric element from overheating, the self-cleaning unit cannot operate for 3 sec. after any



Self Cleaning Sensor Unit



operation. Also, if the self-cleaning unit is operated 5 consecutive times within 10 sec., it will not work for 10 sec. afterward. Turning the power off does not reset this. The restriction does reset if the cleaning function is not activated for at least 60 seconds. While the self-cleaning unit is disabled, if you select [Sensor cleaning: Auto] from the menu, the [Clean now] option will be grayed out and cannot be selected.

Two kinds of dust are less likely to be moved by the accelerations of the vibrating LPF: small and light particles and the dreaded sticky stuff. In the event that the Self Cleaning Sensor Unit cannot remove all the dust, the Dust Delete Data (the size and position of dust too small or too sticky to remove with the Self Cleaning Sensor Unit) is obtained and appended to the image so that Digital Photo Professional Ver. 2.2 can erase the remaining dust spots on the image automatically. The shadows created by the dust particles adhering to low-pass filter #1 are detected by the imaging sensor. The most troubling dust particles, mostly the larger ones, are then singled out and their location coordinates are obtained as Dust Delete Data. This data is attached to the image. After the shutter is released, it takes about 6 sec. to obtain the Dust Delete Data.



Steps to obtain dust delete data

To obtain Dust Delete Data, begin by taking a picture of a solid white, patternless object (such as a piece of white paper) which is quite out of focus despite the use of a small aperture. Use a 50mm or longer lens with manual focus set to infinity. The object should be about 1 foot from the camera. Any common light source is fine. Fill the viewfinder frame. (The image data can be obtained even without a CF card installed in the camera.) When the screen in step 4 appears, the camera will be set automatically as follows: shooting mode, aperture-priority AE; aperture, f/22; shutter speed, 1/2 sec. or faster; ISO Speed, 800\*\*\*; flash, off; drive mode, single.

Even if the focus mode is set to <AF>, manual focus will still take effect, and even if a CF card is installed in the camera, the image taken for the dust deletion will not be recorded. If the picture was overexposed or underexposed by 2 stops or more or if the lighting of the white paper was very uneven, the Dust Delete Data cannot be obtained properly and a message telling you to try again will appear on the screen. The Dust Delete Data obtained is subjoined to both the JPEG and RAW images regardless of the shooting mode. The data is only a few kilobytes, so it will not affect the continuous shooting speed or maximum burst. It is attached to all subsequent images until it is updated again (via the procedure described here). It is recommended that the Dust Delete Data be updated before a big shoot or after changing lenses in a dusty place.

If you use the Dust Delete Data feature and do not want to change the data of the dust coordinates, you can disable the default self-cleaning operation so it does not operate when the power is turned on or off. If you want to stop the Dust Delete Data from being appended to the images, the Dust Delete Data must be erased with the [Clear all camera settings] menu item.

DPP Ver. 2.1 had the copy stamp tool for manually selecting and erasing round dust spots. This feature has been improved with the DPP Ver. 2.2 which can use the Dust Delete Data to erase the dust spots automatically.

When an image contains Dust Delete Data, the automatic dust spot erasing process activates by starting the copy stamp tool and pressing the [Apply Dust Delete Data] button. With DPP Ver. 2.2, the dust spots at the locations specified by the Dust Delete Data are

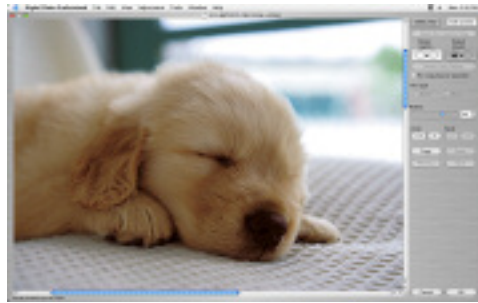

Digital Photo Professional Ver 2.2

detected and erased if doing so is deemed effective. This modest bit of artificial intelligence will be appreciated by anyone who has done a little spotting or retouching because certain things (and it's often difficult to figure out just which ones) look worse after they've been repaired and are better off left alone.

**New High-Precision 9-Point AF System**

The Digital Rebel XTi has the same 9-point AF sensor and AF unit as the EOS 30D, including the sophisticated dual-precision cross-type sensor in the center AF position. This represents a very substantial upgrade from the Digital Rebel XT. The XTi is the first entry-level EOS Digital camera to have an enhanced precision cross-type, center AF point compatible with f/2.8, a feature unique in its class. The XTi has some significant AF performance improvements over the Digital Rebel XT. For example, the XTi has the same wide-area focusing as the EOS 30D. With an f/2.8 or brighter lens, the center AF point detects focus with the f/2.8 light flux. The base line of the center AF point's vertical-line sensitive sensor is twice as long as that of an AF point compatible with f/5.6. This makes focusing detection more precise.

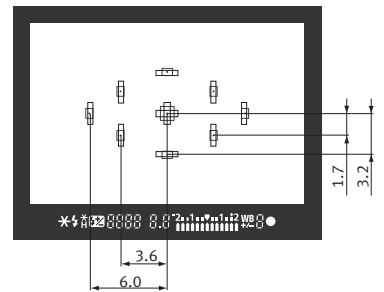
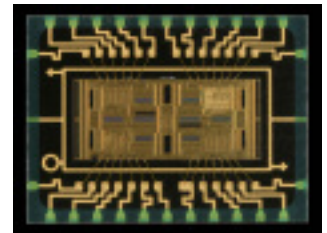

Additionally, the center AF point has a vertical-line sensitive sensor compatible with f/5.6. Therefore, cross-type focusing is possible with any EF lens. The center AF point's horizontal-line sensitive sensor for f/5.6 has a two-line, zigzag pattern. This redundancy of focusing methods makes focus detection more consistent. As in the case of the EOS 30D, fine-tuning has been incorporated to improve the AF precision. Focusing performance under low light has been improved by 1 stop and is now possible from EV -0.5 to

EV 18. Finally, the wider focusing area with nine AF points and the diagonal configuration of AF points in and around the center afford improved subject focus tracking.

Focusing speed is on a par with that of the EOS 30D because the Digital Rebel XTi shares its high-speed 32-bit RISC microcomputer. The algorithm for AI SERVO AF continuous shooting has been fine-tuned and optimized for 3 frames per second.

In the Creative Zone modes, the following AF modes can be selected with the AF mode selection screen: One-Shot AF (when focus is achieved, AF operation stops and locks), Predictive AI SERVO AF (tracks subject movement and focuses continuously until the start of exposure) and AI Focus AF (automatic switching between One-Shot and Predictive AI Servo AF). In the Basic Zone modes, the optimum AF mode is selected automatically, a convenience for the less technically inclined, certainly a part of the XTi's demographic. In the Sports, Flash Off, and Basic Zone's Full Auto modes, the beeper sounds softly (when the beeper is enabled) when focus is achieved with AI SERVO AF. In the Creative Zone modes with AI SERVO AF, the beeper does not sound when focus is achieved. The AF mode can be set even while the lens focus mode switch is set to MF. (When focus is achieved, the focus confirmation icon and superimposed display lights up.) However, "MF" will be displayed on the LCD screen when it displays the camera settings

The predictive AF calculation speed is the same as that of the Digital Rebel XT. With an EF300mm f/2.8L IS USM lens, the camera can focus-track a moving subject approaching at 31 mph/50 kph up to about 32.8 feet/10 meters away. As with the EOS 30D, the lens drive keeps still when focusing a still subject with AI SERVO AF. If the subject begins to move, the camera can start to focus-track the subject immediately because focus detection is conducted continuously. As in the case of the EOS 30D, if you press the shutter button completely in one quick stroke (rather than pressing halfway first), the lens will focus, if possible, before the picture is taken. If focusing is not possible, the picture will be taken anyway to give priority to taking the picture. This extreme instance of shooting priority is especially useful should something occur that is so remarkable that even less than perfect focus will not spoil the record of the moment.

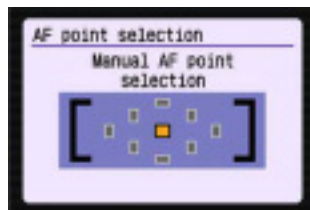

Because the Digital Rebel XTi uses the same AF point selection algorithm as the EOS 30D, there is a high probability that the correct AF point will be selected automatically. The selection procedure is the same as with the Digital Rebel XT. With the Digital Rebel XTi, you can select the AF point manually on the LCD screen's large and easy-to-read display.

As with the Digital Rebel XT, the XTi's AF-assist beam is a series of stroboscopic flashes. It is not emitted in the Landscape, Sports or Flash OFF modes. In a Creative Zone mode, it fires automatically when the built-in flash has been popped up manually. Firing can be enabled/disabled with C.Fn-5. Emission time is 250 ms or less. The working range is approximately 13.1 feet/4 meters at the center and approximately 11.5 feet/3.5

meters at the other 8 AF points. When an external EOS Speedlite is used, the AF-assist beam of the external unit is used.

Speedlite	Automatic Selection	Manual Selection			
		Center	Top/Bottom	Left/Right	Mid-left/Mid-right
580EX	Yes	Yes	Yes	Yes	Yes
550EX	Yes	Yes	—	Yes	Yes
430EX	Yes	Yes	Yes	Yes	Yes
420EX	Yes	Yes	Yes	Yes	Yes
380EX	Yes*	Yes	—	—	—
220EX	Yes*	Yes	—	—	—
ST-E2	Yes	Yes	—	Yes	Yes

\* Focus can be achieved only with the center AF point.

Some of Canon’s competitors have chosen to use in-body image stabilization. The technique involves moving the image sensor in a controlled fashion, based on signals from movement detecting sensors in the camera body. The obvious advantage of this system is that users have some sort of stabilization available with almost any lens they connect to the body. Short focal length lenses require smaller sensor deflections; 24 or 28 mm lenses might need only 1 mm or so. Longer lenses necessitate much greater movement; 300 mm lenses would have to move the sensor about 5.5 mm (nearly 1/4”) to achieve the correction Canon gets with its IS system at the same focal length. This degree of sensor movement is beyond the range of current technology. Short and “normal” focal length lenses need stabilization much less often than long lenses, so the lenses that need the most help get the least. Further, in cameras with smaller than full-frame, 35 mm film size sensors, equivalent focal lengths become longer, by a factor of 1.5 or 1.6, exacerbating the problem by making all lenses longer.

Less significant but still worth mentioning is the fact that in-body stabilization is not visible through the finder, whereas Canon lens-based stabilization definitely is. Also, while in-body stabilization works for many lenses, it does not presently work for all; high magnifications and macro lenses have caused it difficulties.

In the Canon IS system, the Image Stabilizer has an actual lens group that can be moved up and down, or side-to-side, in parallel to the imaging sensor or film plane. A pair of sensors in the lens can detect horizontal or vertical shake. Signals from these sensors are sent instantly to a microprocessor in the lens and analyzed. The microprocessor then causes a group of lens elements, held in place by a device called a coil, to move at the same amplitude and frequency of the shake to cancel it effectively.

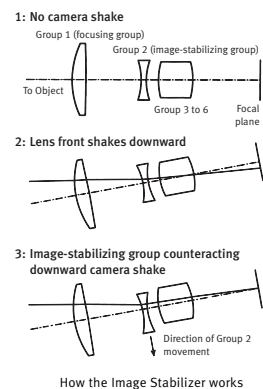

Canon is able to generate excellent image quality by stabilizing the image optically before it ever reaches the imaging sensor in a digital SLR.

With the optical IS used by Canon, each lens with IS has a stabilizer unit designed for that lens's needs. The unit in a lens such as the EF 28-135 f/3.5-5.6 IS USM or the EF-S 17-85 f/4-5.6 IS USM is vastly different from the powerful, broad movement stabilizers

in lenses such as the EF 400mm f/2.8L IS USM or the EF 600mm f/4L IS USM. All over the world, photographers depend on Canon IS to help them achieve the highest possible image quality.

At some point, in-body stabilization may improve to the point at which such technology may be appropriate for certain segments of Canon's DSLR range. It would be senseless to rule out such a possibility. Even now, differences in unit cost are not enough to be significant factors in such a decision. The bottom line is performance.

**New, Highly-Legible  
2.5-inch TFT LCD  
Color Screen**

A 2.5-in., 230,000-pixel, color TFT LCD screen with a wide, 160° viewing angle is a welcome new feature of the Digital Rebel XTi. Compared to the Digital Rebel XT's 1.8-in. LCD screen, the display area is about twice as large. Also, to improve the menu's readability, the font size has been greatly increased. The LCD screen illumination is provided by three LED backlight modules and the brightness adjustment range has been expanded by one level at both the minimum and maximum levels to a total of 7 steps. During brightness adjustment, a handy and elegant grey scale is displayed along with the image.

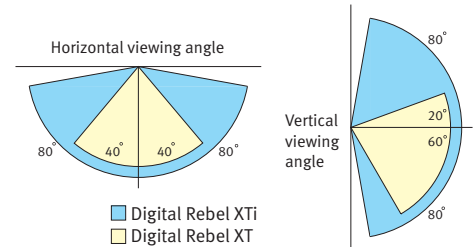

Thanks to a highly transparent LCD screen and a brilliant LED module, screen brightness is about 40% higher than the maximum brightness of the screens found on the EOS-1D Mark II N, EOS 5D, and 30D. This makes it easier to review images even in bright outdoor conditions. At the darkest setting, the display is not uncomfortably bright, even in a dark place. The maximum brightness setting changes the gamma characteristic of the display to increase the midtones, making the image look somewhat overexposed, and high-light detail tends to be lost. Therefore, it is important that when checking an image's exposure and colors, the brightness level be set to one of the middle five levels. Because the Digital Rebel XTi displays the camera settings at all times, users are recommended to set the screen brightness to a suitable level which would not be too bright in the dark.



2.5" LCD Screen

**New Display-off sensor**

When you put your eye on the eyepiece, a new display-off sensor (located below the eyepiece) senses your face and turns off the LCD screen automatically. This is to save battery power and prevent the screen's brightness from disturbing your eye while looking through the viewfinder. The display-off sensor consists of an IRED emitter and light-receiving sensor. When the IRED light reflecting off the face is detected by the light-receiving sensor, the LCD screen turns off automatically. This display-off sensor can be

disabled by setting the [LCD auto off] menu item to [Disable]. The camera setting display can also be turned off and on manually with the <DISP> button (formerly INFO) . If the camera setting display is disabled, it might be difficult to discern whether the camera is turned on or not. A power lamp on the top of the camera is therefore provided to indicate that it is on.

Other than a face, any object that comes near the display-off sensor will turn off the camera setting display temporarily. The camera settings will be displayed again when the face or object goes away from the camera. Also note that if you are wearing sunglasses, they could disperse the IRED light and the display-off sensor might not be able to detect your face. Additionally, if a fluorescent light inverter is within 1 foot/30 cm of the display-off sensor, a pulse may cause the LCD screen to turn off automatically.

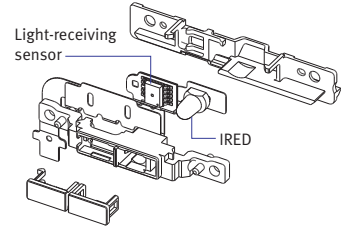

If auto power off is disabled and the camera is left on, the LCD screen will automatically turn off after 30 minutes. (Power will not be turned off.) Normally, the camera settings are displayed whenever the camera is turned on, but to save battery power, you can have the LCD screen remain OFF even after you turn on the camera's power switch. To do this, set C.Fn-11 [LCD display when power ON] to [Retain power OFF status]. This setting enables the camera to start up with the same LCD screen status (ON/OFF) as when the power was turned off.

## New User Interface *Basic operation concept*

The new user interface of the Canon Digital Rebel XTi takes advantage of the state-of-the-art, large, bright and sharp LCD screen to offer a faster, easier and more precise way to operate the camera. The basic operation procedure of using the main dial, cross keys, and various buttons to select and set functions is the same as with the Digital Rebel XT. One difference is the XTi's ability to switch the screen display easily among the camera settings, menu screen and image playback. This is because camera settings are now displayed, one might almost say magnified, on the LCD screen instead of on a separate LCD panel. Other than when the menu screen or image playback is on view, the camera settings are shown at all times unless the display is turned off. While the menu screen or image playback is displayed, pressing the shutter button halfway will bring back the camera settings. With previous cameras, pressing the shutter button halfway turned off the LCD screen.



Camera setting

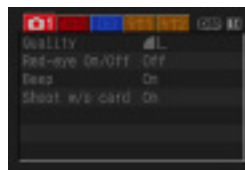

Menu



Image playback

### New info display items

The large LCD screen has enabled 8 new items to be added to the info display compared with the Digital Rebel XT: ISO speed, Dimmer offset, AF frame display, White balance adjustment, White balance bracketing, Beep, Red-eye reduction mode, and Shooting display mode.

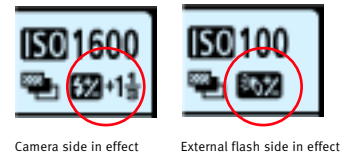

The least obvious of these, and perhaps the most clever, is Dimmer offset. One line down from the top on the far right hand side of the display, either of two icons may appear. The first is a standard lightning bolt with +/- after it. When this symbol, and a number such as  $-2/3$  appears, the display indicates that the built-in flash is set for an exposure reduction of  $2/3$  stop. The other icon is a picture of a Speedlite, followed by the same +/- . If that symbol is displayed, followed by, say,  $+1\ 1/3$ , the display is indicating that the external flash attached to the Digital Rebel XTi is set for an increase in exposure of  $1\ 1/3$  stops.

When exposure correction is applied, the exposure correction display in the center of the second row on the LCD screen changes color for easy reference. The screen also displays error and warning messages and their solutions.

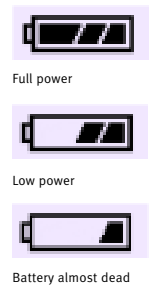

A change to the info display is that the battery power remaining indicator now has 4 levels, rather than 3. The EOS 30D also offers this useful feature.

### Viewfinder

The viewfinder has two additions, both brought from the EOS 30D: an FE lock indicator on the left side, and white balance adjustment, +/-, on the right. The red-eye reduction mark is displayed on the LCD screen, so it is not included in the viewfinder. Viewfinder blackout time is approximately 170 ms at  $1/60$  second or faster shutter speeds. A dioptic adjustment range from  $-3.0$  to  $+1.0$  dpt. is possible and an excellent Precision Matte focusing screen is standard.

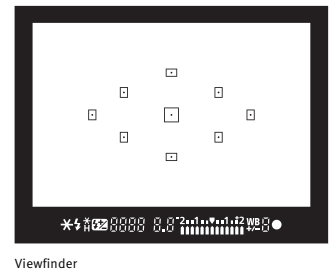

The Digital Rebel XTi has a depth-of-field preview feature, a welcome surprise at the new camera's price point. The button is located near the lens mount, under the left thumb when the XTi is held horizontally. The feature is enabled in the Creative Zone modes.

### SET button, cross keys, DISP.

The SET button is for selecting Picture Style directly. This is its default function. It promotes the use of Picture Styles, clearly differentiating the XTi from its rivals. Also, the Picture Style logo is imprinted below the SET button as a reminder of this capability. The



cross keys are assigned with functions to set the ISO speed, AF mode, white balance, and metering mode. The procedures to set the ISO speed, AF mode, white balance, and metering mode are the same as with the Canon EOS 30D. Settings take effect from the moment they are selected. You no longer need to press the SET button to register the setting.

Although the default setting for the SET button gives direct access to Picture Style, C.Fn.01 can task the button with control of Quality (JPEG quality, RAW, or a combination of the two), Flash exposure compensation (when using external flash, its flash exposure compensation overrides the camera's), Playback (switch instantly to Playback mode) or Cross keys: AF frame selection (cross keys change AF point directly).



The name of the Info button has been changed to DISP. because it now turns the display on and off. Its location is meant to make it easy to turn off the display to save energy.

### *Improvements to playback*

In four playback-related improvements, the Digital Rebel XTi can now display a magnified or reduced view during quick review (C.Fn.10-1, magnified view on image review and playback); automatic image rotation for images taken in vertical orientation may be selected; a highly useful RGB histogram display is now provided, and CF card remaining capacity has been added to the playback info screen.

### *Menus*

As in the case of the Digital Rebel XT, the tabbed menu screens are operated with the cross keys and SET button. Menu operation is possible even during the image writing to the CF card after continuous shooting. Note that functions already assigned to cross keys (ISO speed, etc.) are not included in the menus.

In all, there are 2 shooting menus, a playback menu and 2 set-up menus. The new items are Picture Style and Dust Delete Data added to Shooting 2, Transfer order added to Playback, LCD auto off added to Set-up 1, and Sensor cleaning: auto and Sensor cleaning: manual added to Set-up 2. Changed items are the Histogram in Playback (RGB added), Auto power off, Auto rotate, LCD brightness and File numbering in Set-up 1, and 2 Custom Functions added to Set-up 2. Any of the following 15 languages can be selected for the LCD screen language: English, German, French, Dutch, Danish, Finnish, Italian, Norwegian, Swedish, Spanish, Simplified Chinese, Japanese, Traditional Chinese, Korean and Russian.



## Picture Style

Picture Style, which Canon is implementing across its full EOS Digital range, is new to the sub-\$1000 category. It can be selected directly with the SET button, or through Shooting menu 2. For the first 5 choices, Standard, Portrait, Landscape, Neutral and Faithful, the variables are sharpness, contrast, saturation and color tone. Each Style has preset values for these image characteristics that can be changed by the user in the menu. The process of selecting or refining a Picture Style can be likened to deciding on a film: something a little more saturated and sharper, or perhaps something less forward with a subtle palette and a less-scientific representation of skin textures. The sixth Picture Style is Monochrome, whose variables are Sharpness, Contrast, Filter effect and Toning effect. Last, there are 3 open slots for User Defined styles.



## Custom Functions

The Digital Rebel XTi has 11 Custom Functions with 29 settings to choose from. Four functions were added or changed on the XTi relative to the XT: C.Fn 1: SET button functions (0: Picture Style, 1: Quality, 2: Flash exposure compensation adjustment, 3: Flash exp comp, 4: Cross keys: AF frame selec.), C.Fn 2: Long exposure noise reduction (Off/Auto/On), C.Fn 10: Magnified view (0: Image playback only, 1: Image review and playback), and C.Fn.11: LCD display when power ON (0: Display, 1: Retain power OFF status).

Note that with C.Fn-7-1 (mirror lockup) set, one should not point the camera toward the sun or any bright light source. Doing so can damage the shutter curtains, cause stray light to enter, or damage the imaging sensor.

## Camera Direct Printing

Several useful improvements have been added to the Direct Print feature on the Digital Rebel XTi:

- Contact sheet style 35 image index printing
- Printing with shooting information
- 20 image index printing with shooting information



35-image contact sheet



Single image print with EXIF information

20-image print with EXIF information

- Red-eye reduction function
- Face brightening correction function
- Addition of supported paper sizes (4" x 8", 10" x 12", 8" x 10", 14" x 17")
- Improved printing effects (Natural, Natural M, B/W, Cool Tone, Warm Tone added)
- Adjustment of printing parameters
- Addition of supported paper (Fine Art Photo Rag, Super Photo paper)



without Red-eye reduction

with Red-eye reduction

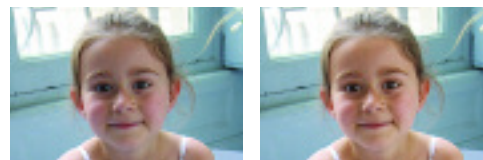

without face brightner

with face brightner

Many of these items appeared on the EOS 30D. Beginners and advanced photographers alike will find them useful and appealing.



PIXMA 6700D and Digital Rebel XTi

In the Digital Rebel XTi, when one uses a printer compatible with this feature, the USB cable can now be disconnected when the image transfer to the printer is completed, even if printing continues. Previously, early cable removal caused the printer to cancel the job. The Print/Share button's blue lamp blinks during image transfer. When the transfer is completed, the blinking stops and the USB cable can be disconnected. This change is a convenience when one is printing multiple images or if the print size is large.

For Print Order (DPOF) and Direct Image Transfer, the specifications are the same as with the EOS 30D. With the Digital Rebel XT, it was necessary to use the Communication menu when switching between direct printing and connection to a personal computer. With the Digital Rebel XTi, the PTP protocol is now the same for both, making it unnecessary to switch. The menu therefore no longer has the Communication setting.

### Direct Image Transfer

As with the EOS 30D, images shot with the Digital Rebel XTi can be transferred directly to a Mac or Windows computer just by connecting the camera to a PC using interface cable IFC-400PCU (included), selecting [EOS Utility] in the dialog that appears, and beginning the transfer by pressing the SET button or the Print/Share button. The choices are:

1. All images-- All images stored in a CF card are transferred to the PC.
2. All images not yet transferred-- Only images that haven't been transferred to the PC are automatically selected for transfer.
3. Images marked for transfer-- Images designated in the menu's [Transfer order] item are transferred to the PC. In [Transfer order], you can choose either [Order] for individual images or [All] for all images. Procedures for marking images for transfer are the same as for marking individual images for DPOF. Up to 998\*\*\* images can be marked.

4. Select image and transfer-- Select images and transfer them to the PC.
5. Wallpaper for computer-- Select an image to use as the background (wallpaper) for the computer screen and transfer it to the PC. A JPEG file is automatically converted into a BMP file to be transferred and appears as the background (wallpaper) for the computer screen. RAW images cannot be transferred for this purpose.

## Design and Construction

The Digital Rebel XTi is a compact, stylish and attractive DSLR that continues the design concept of its predecessor, the Digital Rebel XT. The exterior surface is now coated with a leathery paint finish to make fingernail scratches less noticeable. The Canon logo is a bit bigger to make it stand out better in retail situations (2 mm wider and 0.4 mm higher). To improve holding ease, a convenient new rubber slip guard for the thumb (back, top right) and a new grip shape in the back have been incorporated. The grip is also thicker by 1 mm. The texture of the mode dial has been changed. The Print/Share button is now on the upper left on the back of the camera where the digital control buttons are concentrated. Clearly separating the digital control buttons and camera control buttons makes the camera easier to operate. The new screen and the elimination of the bifurcated display give the back of the camera a cleaner and more integrated appearance.

The camera body construction of the Digital Rebel XTi is very similar to that of the Digital Rebel XT, a camera of proven ruggedness and reliability. The stainless steel chassis and mirror box made of high-strength engineering plastic (polycarbonate with glass fiber) make the body as strong as the XT's. As with the XT, the camera's top, front, and rear covers are made of special engineering plastic (ABS resin, polycarbonate resin, and polycarbonate resin with special conductive fibers) for light weight, high strength, and electromagnetic shielding. The XTi will come in two color versions, silver and black.

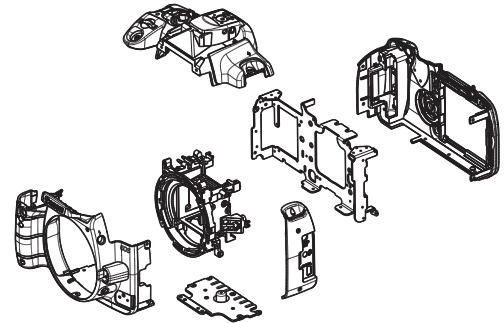

The basic internal components and configuration are the same as those of the Digital Rebel XT. The following units have been added or modified: Self Cleaning Sensor Unit (added), Display-off sensor unit (added), LCD screen (size increased from 1.8 in. to 2.5 in.), LCD panel (eliminated). Note that in every parts category (except lead wires, which remain unchanged at 12), the parts count on the Digital Rebel XTi has increased relative to its predecessor. The total is now 1508, compared to 1319 previously. This is a good, if somewhat generalized, indication that the Digital Rebel XTi is a more sophisticated, and more expensive to produce, camera than the Digital Rebel XT, and that it offers exceptional value in the sub-\$1000 category.

Item	XTi	XT
Optics	21	18
Mechanical parts	245	220
Electrical parts	1046	915
Circuit boards	21	19
Lead wires	12	12
Total (Official)	1345	1184
Screws and washers	163	135
Total	1508	1319

- The shutter unit is counted as 1 part.
- The E-ring is counted as a washer.
- The official total excludes the screws and washers.

The XTi's weight is still very modest although it has increased by 25 grams to 510g/18 oz., excluding battery pack, CF card and body cap, but including the backup battery and the eyecup.

While based on the Digital Rebel XT's electrical components, the XTi's electrical components are compatible with several significant new features, such as the 10.10-megapixel CMOS sensor, Self Cleaning Sensor Unit, Display-off sensor, and the 2.5-in. LCD screen. As with the XT, the XTi's main circuit board is a highly-integrated 8-layer board fitted with the digital control circuit, camera control circuit, image-signal processing circuit, and DC/DC converter circuit. In addition, there are five hard boards, and sixteen flexible boards.

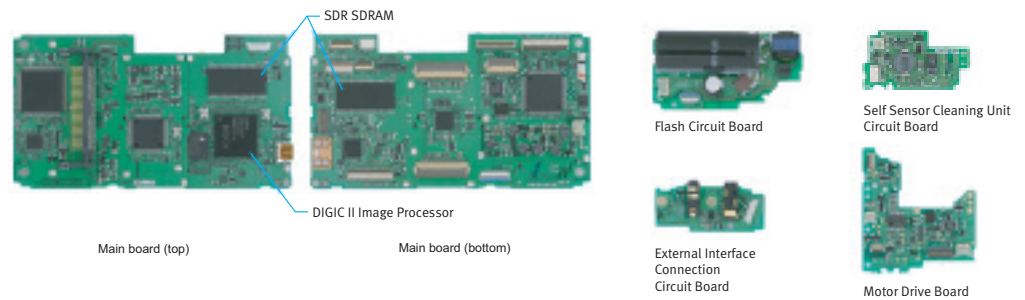

**Interface** The USB 2.0 Hi-Speed, mini B port enables high-speed image transfers from the camera to a personal computer (see Direct Image Transfer) using Interface Cable IFC-400PCU (included). Also, the PTP protocol is now used for both Camera Direct printing and transmissions to a personal computer, making it unnecessary to switch the communications setting.

An NTSC/PAL video output terminal is provided; it uses Video Cable VC-100 (included).

The remote control terminal is compatible with Remote Switch RS-60E3 (2.5 mm dia. mini jack, optional\*\*\*). Wireless remote control is compatible with Remote Controllers RC-1 and RC-5 (optional). The wireless remote control receiver is built inside the camera grip. The system is compatible with all shooting modes and works within approx. 5 m/16.4 ft. (at front and center). When the Drive mode button is pressed, the self-timer/wireless remote control timer icon is displayed on the LCD screen.

**Drive and Power Source** The maximum continuous shooting speed of the Digital Rebel XTi is approx. 3 fps (in both the One-Shot AF and AI SERVO AF modes), the same as the Digital Rebel XT in spite of the larger files the XTi generates. This is achieved by a number of features: the reflex mirror drive and shutter drive are controlled independently; the advanced, Canon-designed and -manufactured CMOS sensor enables high-speed signal reading, and the DIGIC II image processor performs high-speed image processing.

To limit the increase in power consumption required by high-speed reading, the output amp's power consumption has been minimized. Further, during long exposures, power

to the output amp is cut off and the standard current for the circuit drive is also suspended, as in the case of the Digital Rebel XT.

The maximum burst in Large/Fine mode is approx. 27 shots for JPEG and 10 shots for RAW, twice as many as with the Digital Rebel XT. Also, with white balance bracketing enabled, up to 6 shots can be taken continuously, whereas only 2 shots were possible with the XT.

Recording Quality	L/F	L/N	M/F	M/N	S/F	S/N	RAW	RAW+L/F
Max. Burst [Approx.]	27	58	47	112	98	326	10	8

- The figures above are based on Canon's testing standards with a 512MB CF card. (The figures can also vary depending on the CF card.)
- As with the K189, image processing occurs even during continuous shooting. This increases the maximum burst.
- During white balance bracketing, the maximum burst during continuous shooting will be lower.

The Battery Life table indicates the approximate number of shots that can be obtained under varying temperatures and shooting conditions. Using any of the following techniques can conserve power and increase the number of possible shots:

Temperature	Shooting Conditions	
	AE 100%	AE 50% FA 50%
At 23°C / 73°F	500	360
At 0°C / 32°F	370	280

• Based on one fully-charged NB-2LH battery and CIPA testing standards.

1. With the Digital Rebel XT, the shortest power-off time was 1 minute. The default setting for auto power off is now 30 seconds.
2. Because the LCD screen can now be turned off/on with the DISP. button, battery power can be saved even if auto power-off has been disabled or set to a long time period. You can choose to display the camera settings only when needed. To make it easier to press the DISP. button, it is positioned at the top of the column of digital-operation buttons on the camera back.
3. With the C.Fn-11-1 set to [Retain power OFF status], the camera settings will not be displayed. In the Full Auto mode, because one need not worry about the shutter speed and aperture settings, using both C.Fn-11-1 and DISP. to display the camera settings only when necessary will further save battery power.

**Folders** As high-capacity media (2 GB and up) have become more common because of the decline in their cost, Canon has chosen to take advantage by changing folder-related specifications to make them identical to those of Canon's high end models. The changes improve the facility with which one can search for images when large numbers of them are involved. In previous models, one folder could hold up to 100 images; now, 9,999 images can be stored in a single folder. A Force-Reset option has also been added which causes the image number to reset as 0001, and a new folder to be created. Scenes shot separately can now be kept in separate folders, an obvious convenience.

## Accessories and System Compatibility

The Digital Rebel XTi shares its major accessories with the its predecessor, the Digital Rebel XT. The BG-E3 battery grip makes it easy to shoot vertically and has magazines for either two NB-2LH batteries or three AA batteries. The EH18-L semi-hard case and EW-100DBII wide strap continue. Power accessories include the CB-2LW battery charger (for Japan and the Americas), the CB-2LWE charger (for Europe, Asia, South Korea and China), the ACK-DC20/ACK700 AC adapter kits and the CBC-NB2 car battery charger.

With a few minor exceptions, the Digital Rebel XTi is fully compatible with the vast Canon EOS system of EF and EF-S lenses, Speedlites, switches, remotes, cables and adapters.

Interchangeable Lenses	
Lens Mount Converter FD-EOS	Although it can be used with manual exposure, exposure error occurs. Therefore, these items will be officially listed as incompatible.
Macro Lens Mount Converter FD-EOS	
Speedlites	
480EZ	Not compatible
540EZ	Compatible with manual flash (does not fire in A-TTL/TTL autoflash modes).
430EZ	
420EZ	
ML-3	Not compatible (since it only has autoflash modes, it cannot fire).
300EZ	
200E	
Wired multi-Speedlite accessories	(since it cannot fire in Manual flash mode when used with TTL hot shoe adapter).

System accessories not listed above are completely compatible with Digital Rebel XTi.

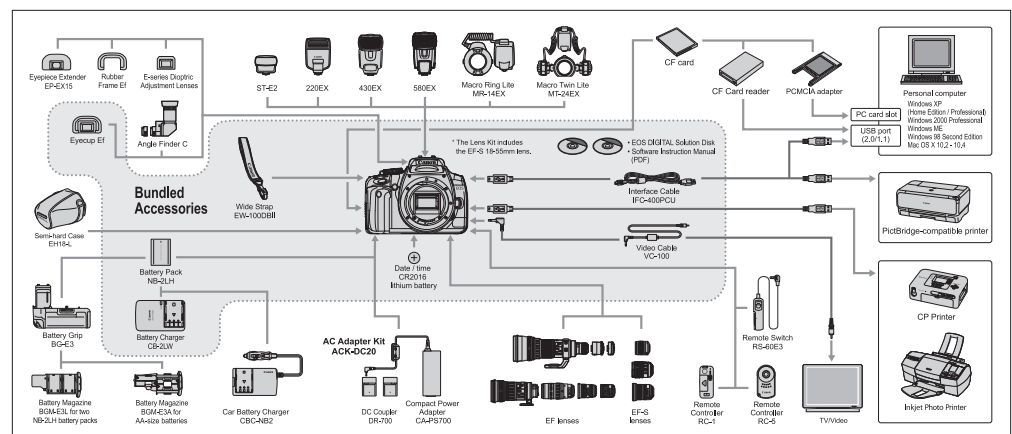

**Software** With the Digital Rebel XTi, Canon continues its tradition of including a complete package of useful and appropriate software at no additional cost with each of its DSLR cameras. The EOS Digital Solution Disk (Ver. 13.0) includes the upgraded Zoom Browser EX (Ver. 5.7, Windows)/Image Browser (Ver. 5.7, Mac), Digital Photo Professional (Ver. 2.2), EOS Utility (Ver. 1.1), Photostitch (Ver. 3.1), and the PTP TWAIN/WIA driver (Windows). The second CD contains information explaining the use of all the application software on the EOS SolutionDisk. The Digital Photo Professional RAW conversion and workflow application now supports Dust Delete Data, and its RGB tone curve adjustment function has been expanded to include an extended range of effectiveness and human face detection.

Supported Operating System	Windows				Macintosh		
	98SE	Me	2000	XP	OS X 10.2	OS X 10.3	OS X 10.4
EOS Utility	–	–	○	○	○	○	○
Digital Photo Professional	–	–	○	○	○	○	○
ZoomBrowser	○	○	○	○	–	–	–
CameraWindow MC	○	○	○	○	○	○	○
RAW Image Task	○	○	○	○	○	○	○
PhotoStitch	○	○	○	○	○	○	○
ImageBrowser	–	–	–	–	○	○	○

Macintosh: Intel Mac (Universal Binary) supported  
Windows: Vista support Schedule under consideration

# IV. SPECIFICATIONS

**Type** **Type:** Digital AF/AE SLR with built-in flash  
**Recording Medium:** CompactFlash (CF) Card Type I & II  
**Image Sensor Size:** 0.87 x 0.58 in./22.2 x 14.8mm (APS-C size sensor)  
**Compatible Lenses:** Canon EF and EF-S lenses  
**Lens Mount:** Canon EF mount  
**Lens Focal Length Conversion Factor:** 1.6x

**Image Sensor** **Type:** High-sensitivity, high-resolution, single-plate, CMOS sensor  
**Effective Pixels:** Approx. 10.10 megapixels  
**Total Pixels:** Approx. 10.50 megapixels  
**Aspect Ratio:** 3:2 (Horizontal : Vertical)  
**Color Filter System:** RGB primary color filters  
**Low-pass Filter:** Fixed position in front of the CMOS sensor  
**Dust Delete Feature:** (1) Auto Sensor Cleaning, (2) Dust Delete Data, (3) Manual Sensor Cleaning

**Recording System** **File Format:** Design rule for Camera File System 2.0 and Exif 2.21  
**Recording Format:** JPEG, RAW, and RAW+JPEG simultaneous recording provided. The RAW and JPEG images are saved as separate files in the CF card.  
**Image Compression:** JPEG, RAW (Canon .CR2)  
**File Size:** (1) Large/Fine: Approx. 3.8MB (3,888 x 2,592), (2) Large/Normal: Approx. 2.0MB (3,888 x 2,592), (3) Medium/Fine: Approx. 2.3MB (2,816 x 1,880), (4) Medium/Normal: Approx. 1.2MB (2,816 x 1,880), (5) Small/Fine: Approx. 1.3MB (1,936 x 1,288), (6) Small/Normal: Approx. 0.7MB (1,936 x 1,288), (7) RAW: Approx. 9.8MB (3,888 x 2,592)  
**Folders:** Automatic folder creation; up to 9,999 images per folder (new folder created when the file number reaches 9999)  
**File Numbering:** (1) Continuous numbering (2) Auto reset (3) Manual reset (the image numbering is reset to 0001, a new folder is created where subsequent images are saved)  
**Color Space:** Selectable between sRGB and Adobe RGB  
**Picture Style:** Six preset Picture Style settings plus three user-defined custom Picture Style settings with individual adjustments for Sharpness, Contrast, Color saturation, 2nd Color tone; Filter effect, Toning effect for black & white images  
**Interface:** USB 2.0 Hi-Speed, mini-B port. NTSC/PAL for video output



**White Balance** **Settings:** Auto, Preset (Daylight, Shade, Cloudy, Tungsten Light, White Fluorescent Light, Flash), Manual (Custom, or user-set Color Temperature)  
Auto White Balance: Auto white balance with the image sensor  
Color Temperature Compensation: White balance bracketing: +/- 3 stops in 1-stop increments;  
**White balance correction:** blue/amber bias +/- 9 levels, magenta/green bias +/- 9 levels.  
When blue/amber bias and magenta/green bias set with White balance correction, white balance bracketing cannot be set to more than +/- 9 levels

**Viewfinder** **Type:** Eye-level SLR with pentamirror  
**Coverage:** Approx. 95% horizontally and vertically  
**Magnification:** 0.8x (-1 dpt with 50mm lens at infinity)  
**Eyepoint:** Approx. 21mm  
**Dioptric Adjustment Correction:** -3.0 to +1.0 diopter  
**Mirror:** Quick-return half mirror (Transmission: reflection ratio of 40:60)  
**Viewfinder Information:** AF (AF points, focus confirmation light), Exposure (shutter speed, aperture, exposure level, AE lock, exposure compensation, AEB level, bulb), Flash (flash ready, red-eye reduction lamp on, high-speed sync, FE lock, FEB shooting, flash exposure compensation, insufficient flash warning during FE lock), White balance correction, Maximum burst, CF card full warning, CF card error warning, No CF card warning  
**Depth-of-Field Preview:** Enabled with depth-of-field preview button (with Speedlite 580EX, 430EX, MR-14EX or MT-24EX; pressing the depth-of-field preview button fires a modeling flash)  
**Eyepiece Shutter:** None (eyepiece cover provided on strap)

**Autofocus** **Type:** TTL-CT-SIR with CMOS sensor  
**AF points:** 9 AF points  
**AF Working Range:** EV -0.5–18 (ISO 100 at 73°F/23°C)  
**Focusing Modes:** Autofocus: One-Shot AF, Predictive AI Servo AF, AI Focus AF (automatic switching between One-Shot/Predictive AI Servo AF); Manual Focus (MF)  
**AF Point Selection:** Automatic selection, Manual AF point selection  
**Selected AF Point Display:** Superimposed on viewfinder and LCD monitor  
**AF-assist Beam:** Intermittent firing of built-in flash (Emitted automatically when necessary under low light, and linked to all 9 AF points. Not emitted in the Landscape, Sports and Flash OFF modes)

<b>Exposure Control</b>	<p><b>Metering Modes:</b> Max. aperture TTL metering with 35-zone SPC, (1) Evaluative metering (linked to all AF points), (2) Partial metering (approx. 9% at center of viewfinder), (3) Center-weighted average metering</p> <p><b>Metering Range:</b> EV 1–20 (ISO 100 at 73°F/23°C with EF 50mm f/1.4 USM lens)</p> <p><b>Exposure Control Systems:</b> Program AE (shiftable), Shutter-priority AE, Aperture-priority AE, Auto Depth-of-field AE (non-shiftable), Full auto (Program AE, non-shiftable), Programmed image control modes, Manual exposure (including bulb), E-TTL II autoflash program AE</p> <p><b>ISO Speed Range:</b> Basic Zone: automatically set by the camera; Creative Zone: equivalent to ISO 100–1,600</p> <p><b>Exposure Compensation:</b> (1) User-set with multi-controller (2) AEB (Auto Exposure Bracketing);</p> <p><b>Bracketing range:</b> +/- 2 stops in 1/3- or 1/2-stop increments</p> <p><b>AE Lock:</b> Auto: Applied in One-Shot AF mode with evaluative metering when focus is achieved</p> <p><b>User-set:</b> Applied with AE lock button</p>
<b>Shutter</b>	<p><b>Type:</b> Vertical-travel, mechanical, focal-plane shutter with all speeds electronically controlled</p> <p><b>Shutter Speeds:</b> 1/4000 to 30 sec. (1/3- and 1/2-stop increments), X-sync at 1/200 sec.</p> <p><b>Shutter Release:</b> Soft-touch electromagnetic release; shutter “lag time” approx. 100 msec.</p> <p><b>Self-Timer:</b> 10 sec. delay, 2 sec. delay with C.Fn-7-1 (mirror lockup)</p> <p><b>Remote Control:</b> Remote control with Remote Switch RS-60E3 or Wireless Remote Controllers RC-1/RC-5.</p>
<b>Built-in Flash</b>	<p><b>Type:</b> Auto pop-up, retractable, built-in flash in the pentaprism</p> <p><b>Guide Number:</b> 43 ft./13m (ISO 100)</p> <p><b>Recycling Time:</b> Approx. 3 sec.</p> <p><b>Flash-ready Indicator:</b> Flash-ready indicator lights in viewfinder</p> <p><b>Flash Coverage:</b> 17mm lens focal length (equivalent to 27mm in 135 format)</p> <p><b>Flash Metering System:</b> E-TTL II autoflash</p> <p><b>Flash Exposure Compensation:</b> +/-2 stops in 1/3- and 1/2-stop increments</p> <p><b>EOS External Flash or Dedicated Speedlite:</b> E-TTL II autoflash with EX Series Speedlites</p>
<b>Drive System</b>	<p><b>Drive Modes:</b> Single, Continuous, Self-timer/Remote control</p> <p><b>Continuous Shooting Speed:</b> Approx. 3 fps (at a shutter speed of 1/250 sec. or faster)</p> <p><b>Max. Burst During Continuous Shooting: JPEG:</b> approx. 27 frames (Large/Fine); <b>RAW:</b> approx. 10 frames; <b>RAW+JPEG:</b> approx. 8 frames (Large/Fine)</p>

**LCD Monitor** **Type:** TFT color, liquid-crystal monitor  
**Monitor Size:** 2.5 in. diagonal with a viewing angle of approx. 160° vertically and horizontally  
**Pixels:** Approx. 230,000 pixels  
**Coverage:** Approx. 100%  
**Brightness Control:** 7 levels provided

**Playback** **Image Display Format:** Single image, 9-image index, Magnified zoom (approx. 1.5x to 10x), Auto play, Auto review right after shooting, Histogram, Rotate, Jump  
**Highlight Alert:** In the single image (INFO) display mode, the highlight portions containing no image information will blink

**Image Protection And Erase** **Protection:** A single image can be protected or unprotected  
**Erase:** A single image or all images stored in a CF card can be erased if they are unprotected  
**Direct Printing from the Camera:** Enabled with the Print/Share button  
**Compatible Printers:** CP and SELPHY Compact Photo Printers, PIXMA Photo Printers and PictBridge compatible printers (via USB Interface Cable IFC-400PCU)  
**Settings:** Print quantity, style (image, paper size, borders, date), trimming

**Menus** **Menu Categories:** Shooting menu: red, Playback menu: blue, Setup menu: yellow  
**LCD Monitor Languages:** 15 languages provided (English, German, French, Dutch, Danish, Finnish, Italian, Norwegian, Swedish, Spanish, Russian, Simplified Chinese, Traditional Chinese, Korean, Japanese)  
**Firmware Update:** Enabled by the user

**Power Source** **Battery:** One Battery Pack NB-2LH

**Number of Shots**

Configuration		No Flash Used	50% with Flash
NB-2LHX1	Normal temp (73°F/23°C)	500 frames	360 frames
	Low temp (32°F/0°C)	370 frames	280 frames
NB-2LHX2	Normal temp (73°F/23°C)	1000 frames	720 frames
	Low temp (32°F/0°C)	740 frames	560 frames

**Dimensions And Weight** **Dimensions (W x H x D):** 4.98 x 3.71 x 2.56 in./126.5 x 94.2 x 65mm  
**Weight:** 18 oz./510g (body only)

**Operating Environment**    **Operating Temperature Range:** 32–104°F/0–40°C  
**Operating Humidity Range:** 85% or less

Canon and DIGIC are registered trademarks, and SELPHY and PIXMA are trademarks, of Canon Inc. in the United States and may also be registered trademarks or trademarks in other countries. IMAGEANYWARE is a trademark of Canon. Microsoft and Windows are trademarks or registered trademarks of the Microsoft Corporation in the United States and/or other countries. Mac is a trademark of Apple Computer, Inc., registered in the United States and other countries. Adobe Photoshop is a registered trademark of Adobe Systems incorporated and its subsidiaries in each country. All other products and brand names are registered trademarks, trademarks or service marks of their respective owners.

- All the specifications above are based on Canon's Standard Test Method.
- The camera's specifications and physical appearance are subject to change without notice.
- TFT monitor images shown in this white paper are simulated.

Microsoft® and Windows® are registered trademarks or trademarks of Microsoft Corporation in the United States and / or other countries, Macintosh® is a registered trademark or trademark of Apple Computer Inc. in the United States and / or other countries. CompactFlash™ is a trademark of SanDisk Corporation. Microdrive™ is a trademark of IBM Corporation. Adobe Photoshop is a registered trademark of Adobe Systems Incorporated and its subsidiaries in each country. The other product and brand names appearing in this brochure are trademarks or registered trademarks of their respective owners. TFT monitor images shown in this brochure are simulated.

# V. CONCLUSION

The Canon Digital Rebel XTi is a formidable camera on many levels. Its image quality is unequaled in its category and is good enough to be compared favorably with cameras costing up to twice as much. Its ease of use enables owners with any level of expertise to get superb results. Its comprehensive dust solution mitigates one of the true annoyances of DSLR ownership. Its compact body and refined ergonomics make it a pleasure to live with.

The Digital Rebel XTi will certainly be a great success in the marketplace. As photographers become acquainted with the XTi, it is likely that advanced amateurs and professionals will find it as irresistible as beginners will. For journalists, wedding photographers and portraitists, it has the resolution, the image quality and the proven reliability to serve nobly. When its complete compatibility with the legendary Canon EOS system is taken into account, the Digital Rebel XTi will certainly be recognized by photographers everywhere as the finest value and most appealing sales proposition of any DSLR in its price class and well beyond.

Contents ©2006 by Canon U.S.A., Inc. All Rights Reserved. Excerpts from this material may be quoted in published product reviews and articles. For further information, please contact Canon U.S.A., Inc. Public Relations Dept., (516) 328-5000.